

240x238x49

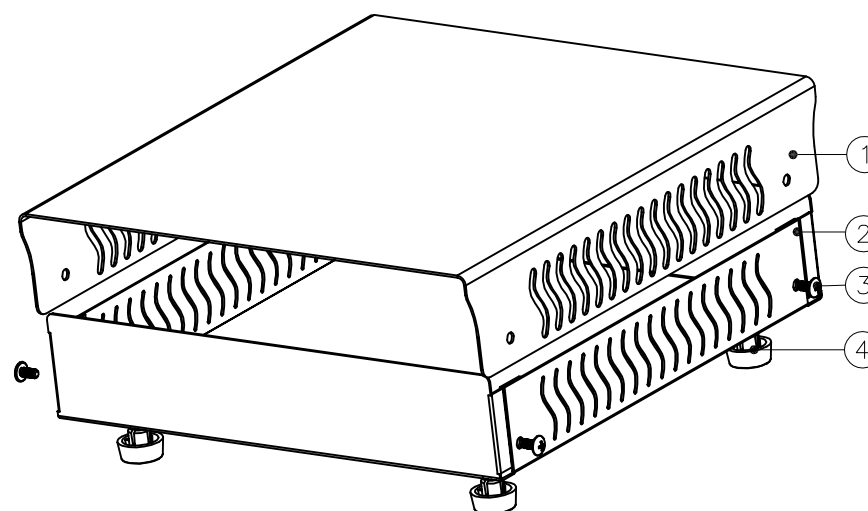

4	foot pad	TPE	4	BP-20			
3	screws	STD	4	STM4X8			
2	bottom cover	SECC	1	/			
1	Uppre cover	SECC	1	/			
Drawing	Auditing	Confirm	Product Name	Iron case	Project View		A
			Product Type	BDA 40063	Drawing Scale	1:1 (MM)	

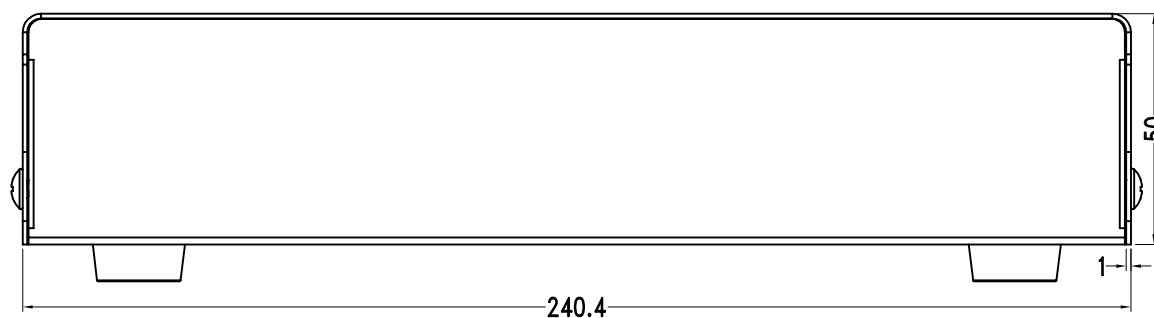

BAHAR ENCLOSURE GmbH