

产品型号(MODEL NO.): BMC 70002-A1

产品尺寸 ( SIZE ): 238×134×58 mm

产品重量(WEIGHT):



2 1 2 2 2 2 6 1

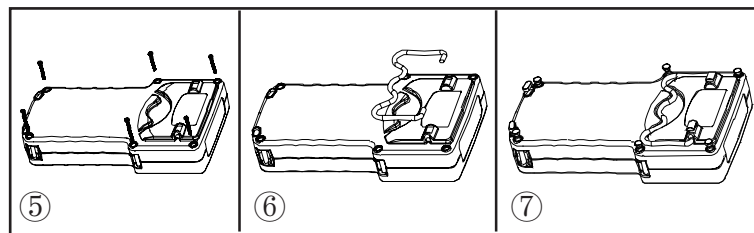
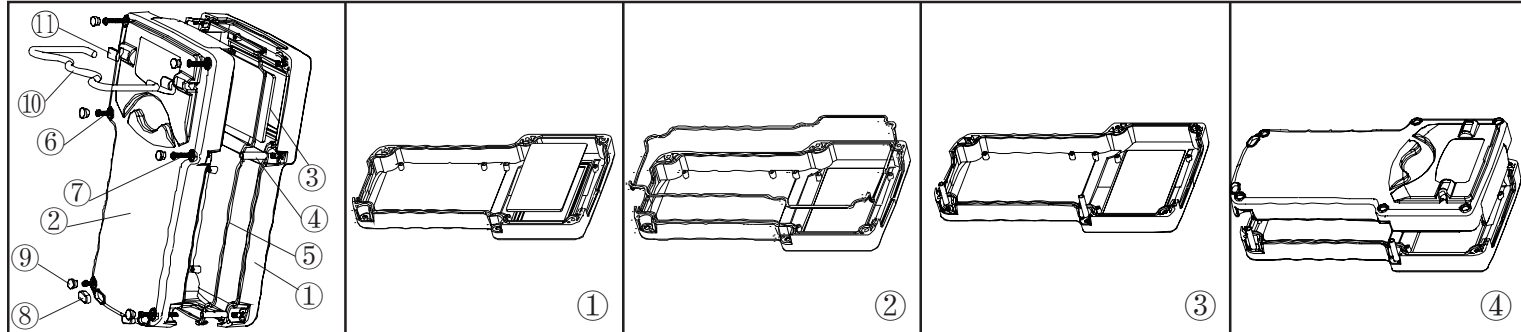

①



产品编号(NUMBER):  
产品名称(NAME):上壳 EPIVALVE  
模具编号(P/NO): BAH10050-A1A2  
材料(MATERIAL):ABS(LIGHT GREY:FS20412)  
用量(QUANTITY):1 PCS  
重量(WEIGHT):

②



产品编号(NUMBER):  
产品名称(NAME):下壳 HYPOTHECA  
模具编号(P/NO): BAH10050-A1A2  
材料(MATERIAL):ABS(LIGHT GREY:FS20412)  
用量(QUANTITY): 1 PCS  
重量(WEITHG):

③

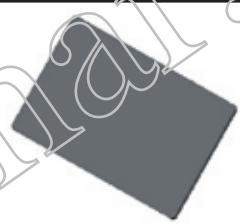

产品编号(NUMBER): PC片 PC TABLET  
产品名称(NAME):下壳 HYPOTHECA  
模具编号(P/NO):  
材料(MATERIAL):  
用量(QUANTITY): 1 PCS  
重量(WEITHG):

④

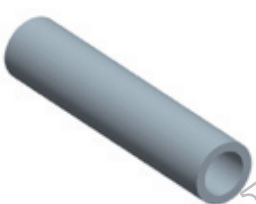

产品编号(NUMBER): 钢管 STEEL TUBE  
产品名称(NAME):  
模具编号(P/NO):  
材料(MATERIAL):STAINLESS STEEL PIPE  
用量(QUANTITY): 2 PCS  
重量(WEITHG):

⑤



产品编号(NUMBER):  
产品名称(NAME):  
模具编号(P/NO):  
材料(MATERIAL):橡胶 RUBBER  
用量(QUANTITY): 1 PCS  
重量(WEITHG):

⑥

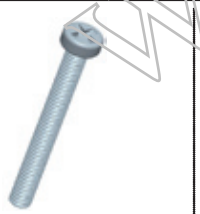

产品编号(NUMBER): PM3X25  
产品名称(NAME):螺丝 SCREW  
模具编号(P/NO): M3X25  
材料(MATERIAL):不锈钢 STAINLESS STEEL  
用量(QUANTITY): 4 PCS  
重量(WEITHG):

⑦



产品编号(NUMBER): PM3X35  
产品名称(NAME):螺丝 SCREW  
模具编号(P/NO): M3X35  
材料(MATERIAL):不锈钢 STAINLESS STEEL  
用量(QUANTITY): 2 PCS  
重量(WEITHG):

⑧



产品编号(NUMBER):  
产品名称(NAME):软脚垫 SOFT PAWS  
模具编号(P/NO): BAH10050-A3A4  
材料(MATERIAL):ABS(LIGHT GREY:FS20412)  
用量(QUANTITY): 2 PCS  
重量(WEITHG):

⑨



产品编号(NUMBER): BP-9  
产品名称(NAME):脚垫 FOOT PAD  
模具编号(P/NO): BAH10020-A4  
材料(MATERIAL):PP(LIGHT GREY:FS20412)  
用量(QUANTITY): 6 PCS  
重量(WEITHG):

⑩



产品编号(NUMBER):  
产品名称(NAME):SUPPORTING FRAME  
材料(MATERIAL): 不锈钢 STAINLESS STEEL  
用量(QUANTITY): 1 PCS  
重量(WEITHG):

⑪

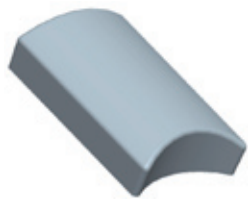

产品编号(NUMBER):  
产品名称(NAME):软脚垫 SOFT PAWS  
模具编号(P/NO): BAH10050-A3A4  
材料(MATERIAL):ABS(LIGHT GREY:FS20412)  
用量(QUANTITY): 2 PCS  
重量(WEITHG):