

SEC B-B

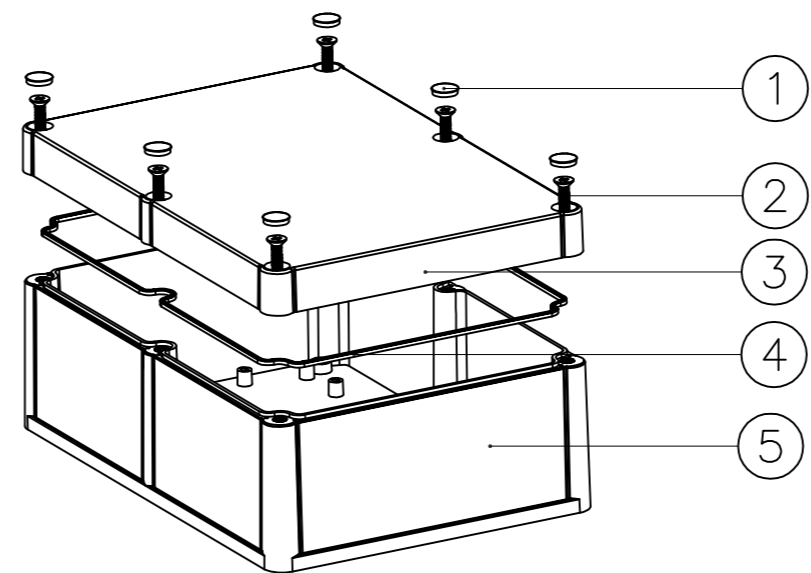

5	bottom cover	ABS	1	10518-B1			
4	seal ring	silica gel	1	10018-C1			
3	Uppre cover	ABS	1	10018-A1			
2	screws	STD	6	KM4X25			
1	Screw cap	ABS	6	KN-500-A1			
Drawing	Auditing	Confirm	Product Name	Water proof Enclosure	Project View		A
			Product Type	BWP 10518	Drawing Scale	1:1 (MM)	