

SEC A-A

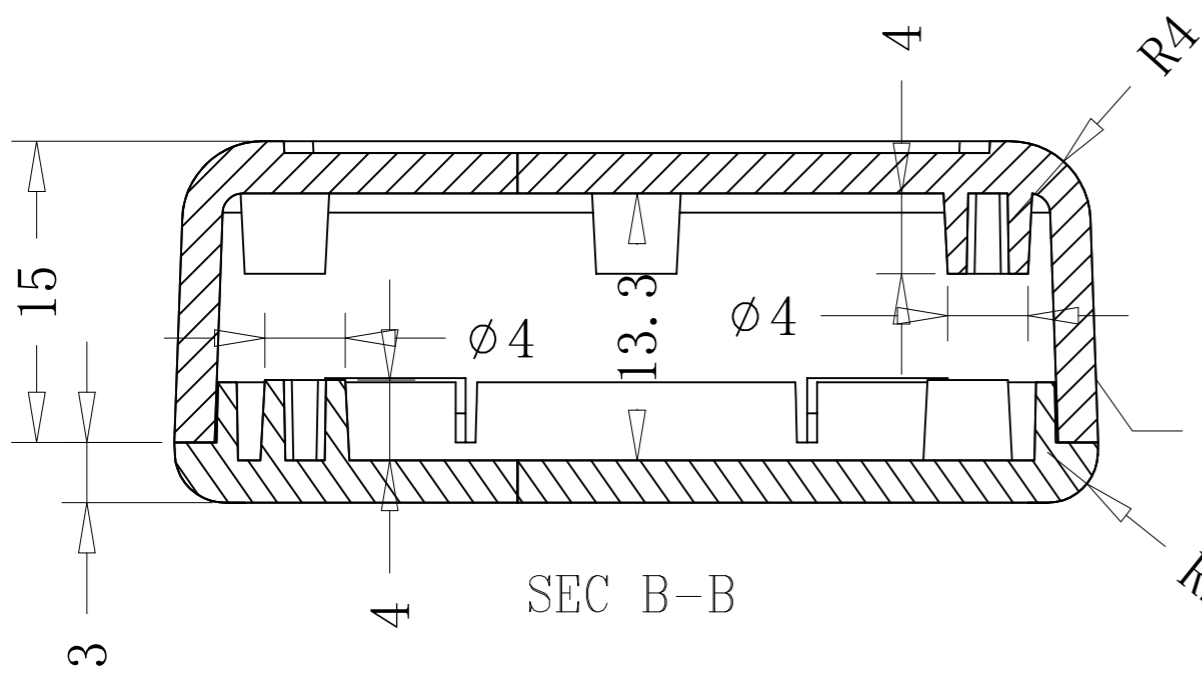

SEC B-B

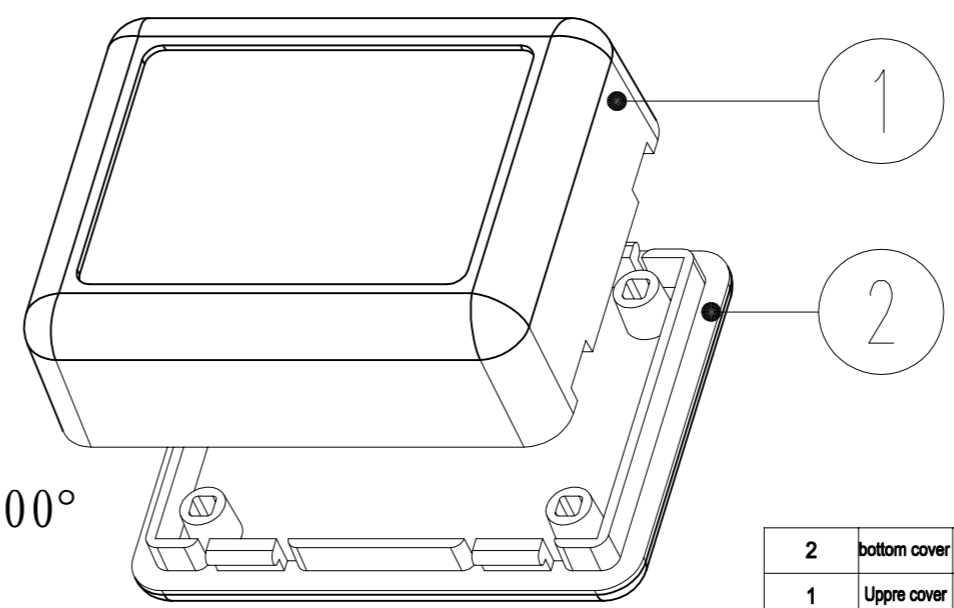

2	bottom cover	ABS	1	60012-C1			
1	Uppre cover	ABS	1	60012-B1			
Drawing	Auditing	Confirm	Product Name	Desk-top Enclosure	Project View		A
			Product Type	BMD 60012	Drawing Scale	1:1 (MM)	