

SEC A-A

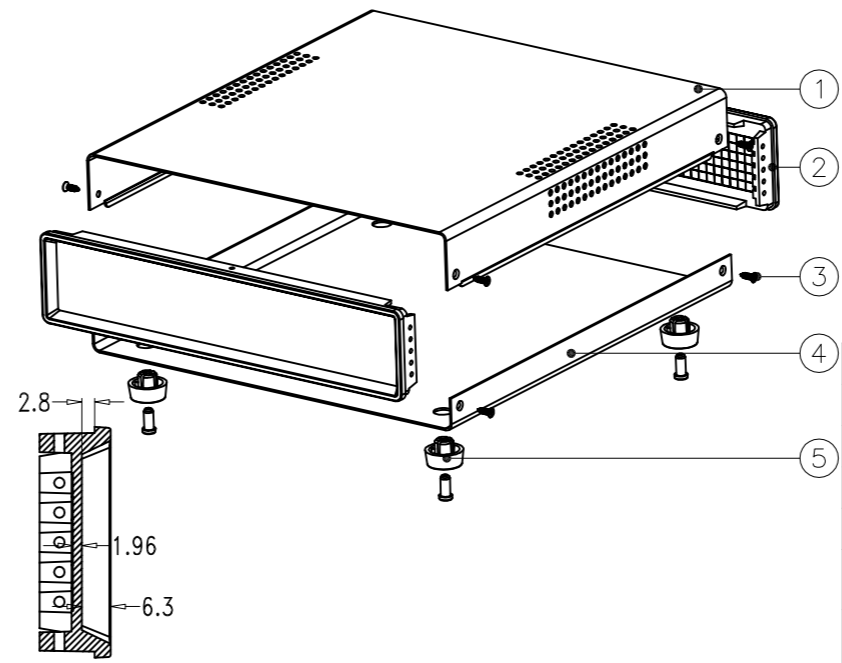

SEC B-B

5	foot pad	TPE	4	BP-20	
4	bottom cover	Electrolytic sheet	1	40011-W250-C1	1.0MM
3	screws	STD	8	KA3X10	
2	panel	ABS	2	40011-A1	
1	Uppre cover	Electrolytic sheet	1	40011-W250-B1	1.0MM
Drawing	Auditing	Confirm	Product Name	Metal Enclosure	Project View
			Product Type	BDA 40011 (W250)	Drawing Scale
					1:1 (MM)