

产品型号(MODEL NO.): BWP 10603-A1

产品尺寸 (SIZE): 331×256×77MM

产品重量(WEIGHT):

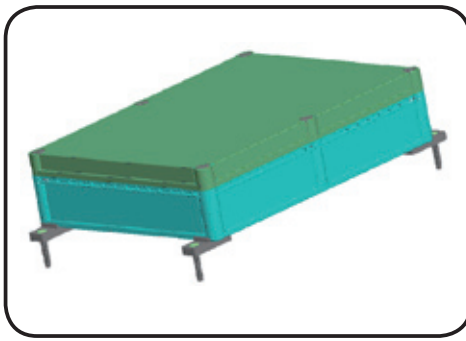

11226004

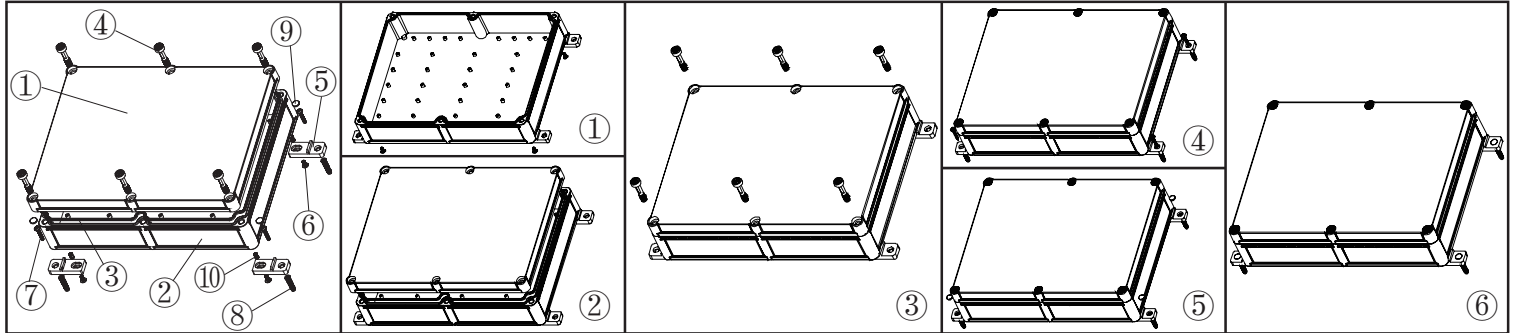

①



产品编号(NUMBER):10603-B1
 产品名称(NAME):上壳 EPIVALVE
 模具编号 (P/NO):BAH10051-A1
 材料(MATERIAL):ABS(LIGHT GREY:FS20412)
 用量(QUANTITY):1 PCS
 重量(WEIGHT):

②

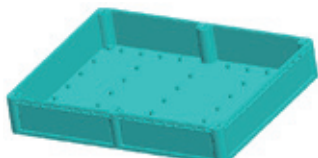

产品编号(NUMBER): 10603-C1
 产品名称(NAME):下壳 HYPOTHECA
 模具编号(P/NO): BAH10051-A3
 材料(MATERIAL):ABS(LIGHT GREY:FS20412)
 用量(QUANTITY): 1 PCS
 重量(WEIGHT):

③



产品编号(NUMBER): 10603-D1
 产品名称(NAME):防水圈GASKET
 材料 (MATERIAL): 橡胶RUBBER
 用量(QUANTITY): 1 PCS
 尺寸 (SIZE): 326.3x251.3x2.4 MM
 重量(WEIGHT):

④



产品编号(NUMBER): 10601-E1
 产品名称(NAME): 螺丝 SCREW
 模具编号(P/NO): BAH10027-A4
 规格(STANDARD):
 材料(MATERIAL): PC
 用量(QUANTITY): 6 PCS

⑤



产品编号(NUMBER):10601-F1
 产品名称(NAME):墙挂WALL TIE ACCESSORIES
 模具编号 (P/NO):BAH10027-A3
 材料(MATERIAL):ABS(LIGHT GREY:FS20412)
 用量(QUANTITY): 4 PCS

⑥

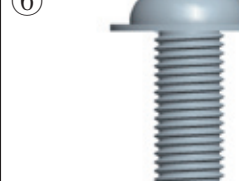

产品编号(NUMBER): PWM4×10
 产品名称(NAME):螺丝 SCREW
 规格(STANDARD): M4×10
 材料(MATERIAL):STAINLESS STEEL
 用量 (QUANTITY): 4 PCS

⑦



产品编号(NUMBER):PWA4×30
 产品名称(NAME):自攻螺丝SELF-TAPPING SCREW
 规格(STANDARD): M4×30
 材料(MATERIAL):铁 IRON
 用量(QUANTITY): 4 PCS

⑧



产品编号(NUMBER): S-6
 产品名称(NAME): 墙钉 WALL NAIL
 模具编号(P/NO): BAH10032-A1A2
 规格(STANDARD): S×6 φ4-5
 材料(MATERIAL): PP(GREY:CM906)
 用量(QUANTITY): 4 PCS

⑨

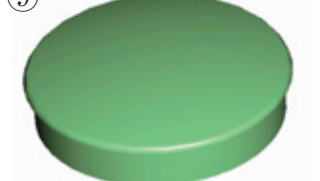

产品编号(NUMBER): KN-500-B1
 产品名称(NAME): 螺丝盖 SCREW LID
 模具编号(P/NO): BAH10001-A3
 材料(MATERIAL): ABS(LIGHT GREY:FS20412)
 用量(QUANTITY): 4 PCS

⑩

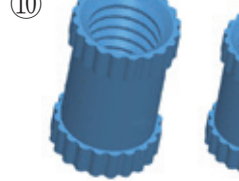

产品编号(NUMBER): M4×8 / M4×6
 产品名称(NAME): 铜套 COPPER NUT
 规格(STANDARD): M4×8 / M4×6
 材料(MATERIAL): 铜 COPPER
 用量(QUANTITY): 4 PCS/6PCS
 颜色 (COLOR): 铜色 COPPER

名称 NAME	尺寸 SIZE (MM)	CARTON No.	G . W (KG)	N . W (KG)	每箱数量 QUANTITY	PE袋 POLYBAG
小箱 SAMLL CARTON						
大箱 BIG CARTON						