

产品型号(MODEL NO.): BWP 10602-A2

产品尺寸 ( SIZE ): 268×198×102MM

产品重量(WEIGHT):

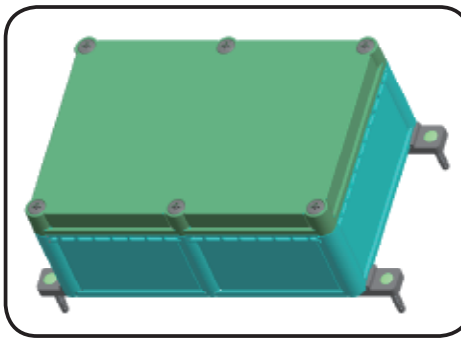

1 1 2 2 6 0 0 3

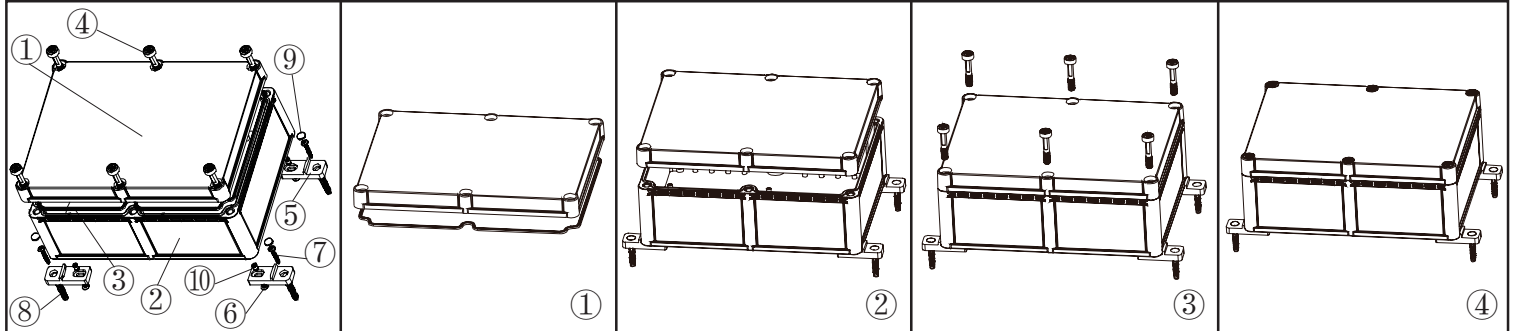

①

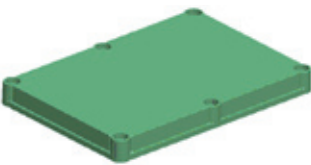

产品编号(NUMBER):10602-B2  
 产品名称(NAME):上壳 EPIVALVE  
 模具编号 (P/NO):BAH10027-A1  
 材料(MATERIAL):PC(TRANSPARENCE)  
 用量(QUANTITY):1 PCS  
 重量(WEIGHT):

②

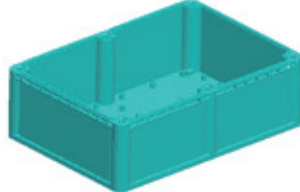

产品编号(NUMBER): 10602-C1  
 产品名称(NAME):下壳 HYPOTHECA  
 模具编号(P/NO): BAH10027-A2  
 材料(MATERIAL):ABS(LIGHT GREY:FS20412)  
 用量(QUANTITY): 1 PCS  
 重量(WEIGHT):

③



产品编号(NUMBER): 10602-D1  
 产品名称(NAME):防水圈GASKET  
 材料 (MATERIAL): 橡胶RUBBER  
 用量(QUANTITY): 1 PCS  
 尺寸 (SIZE): 263.5x193.3x2.4 MM  
 重量(WEIGHT):

④



产品编号(NUMBER): 10601-E1  
 产品名称(NAME): 螺丝 SCREW  
 模具编号(P/NO): BAH10027-A4  
 规格(STANDARD):  
 材料(MATERIAL): PC  
 用量(QUANTITY): 6 PCS

⑤



产品编号(NUMBER):10601-F1  
 产品名称(NAME):墙挂WALL TIE ACCESSORIES  
 模具编号 (P/NO):BAH10027-A3  
 材料(MATERIAL):ABS(LIGHT GREY:FS20412)  
 用量(QUANTITY): 4 PCS

⑥



产品编号(NUMBER): PWM4×10  
 产品名称(NAME):螺丝 SCREW  
 规格(STANDARD): M4×10  
 材料(MATERIAL):STAINLESS STEEL  
 用量 (QUANTITY): 4 PCS

⑦



产品编号(NUMBER):PWA4×30  
 产品名称(NAME):自攻螺丝SELF-TAPPING SCREW  
 规格(STANDARD): M4×30  
 材料(MATERIAL):铁 IRON  
 用量(QUANTITY): 4 PCS

⑧



产品编号(NUMBER): S-6  
 产品名称(NAME): 墙钉 WALL NAIL  
 模具编号(P/NO): BAH10032-A1A2  
 规格(STANDARD): S×6 φ4-5  
 材料(MATERIAL): PP(GREY:CM906)  
 用量(QUANTITY): 4 PCS

⑨

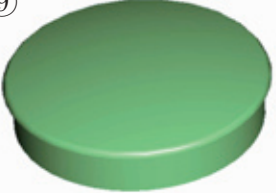

产品编号(NUMBER): KN-500-B1  
 产品名称(NAME): 螺丝盖 SCREW LID  
 模具编号(P/NO): BAH10001-A3  
 材料(MATERIAL): ABS(LIGHT GREY:FS20412)  
 用量(QUANTITY): 4 PCS

⑩

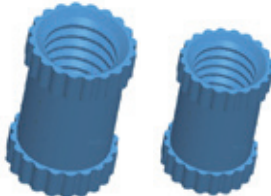

产品编号(NUMBER): M4×8 / M4×6  
 产品名称(NAME): 铜套 COPPER NUT  
 规格(STANDARD): M4×8 / M4×6  
 材料(MATERIAL): 铜 COPPER  
 用量(QUANTITY): 4 PCS/6PCS  
 颜色 (COLOR): 铜色 COPPER

名称 NAME	尺寸 SIZE (MM)	CARTON No.	G . W (KG)	N . W (KG)	每箱数量 QUANTITY	PE袋 POLYBAG
小箱 SAMLL CARTON						
大箱 BIG CARTON						