

产品型号(MODEL NO.): BWP 10513-A1

产品尺寸 (SIZE): 161.5×94×66MM

产品重量(WEIGHT):

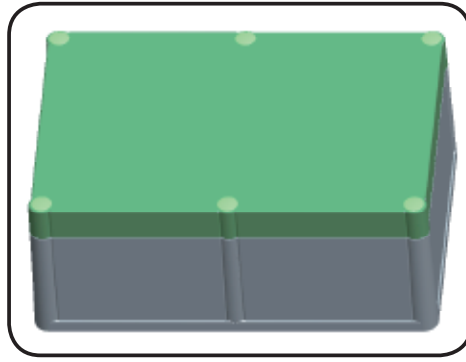

1 1 2 2 3 0 2 4

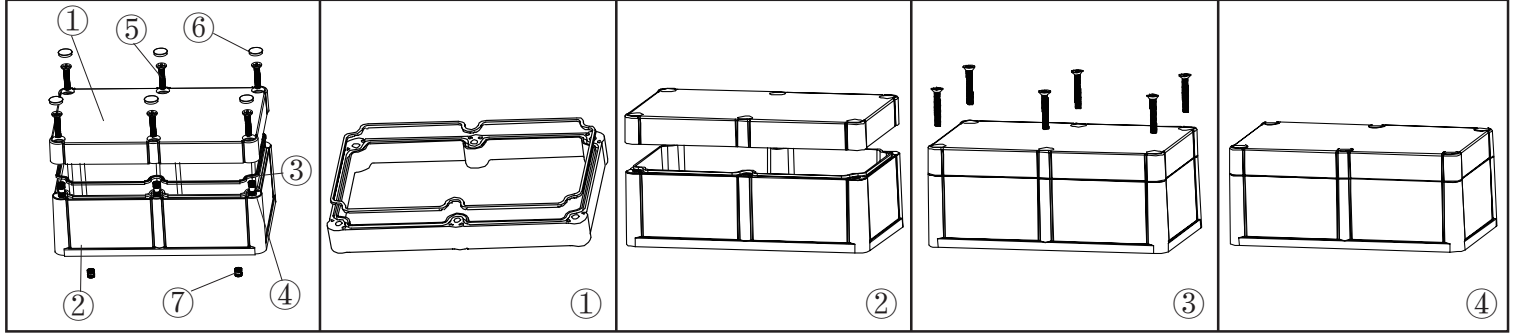

①



产品编号(NUMBER): 10013-B1
 产品名称(NAME): 上壳 EPIVALVE
 模具编号 (P/NO) :BAH10025-B3
 材料(MATERIAL):ABS(LIGHT GREY:FS20412)
 用量(QUANTITY):1 PCS
 重量(WEIGHT):

②

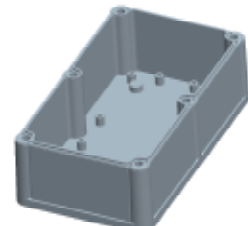

产品编号(NUMBER): 10503-C1
 产品名称(NAME): 下壳 HYPOTHECA
 模具编号(P/NO): BAH10025-B1B2
 材料(MATERIAL):ABS(LIGHT GREY:FS20412)
 用量(QUANTITY): 1 PCS
 重量(WEITHG):

③



产品编号(NUMBER): 10002-D1
 产品名称(NAME): 防水圈GASKET
 材料 (MATERIAL): 橡胶RUBBER
 用量(QUANTITY): 1 PCS
 尺寸 (SIZE): 155x87x1.8 mm
 重量(WEIGHT):

④

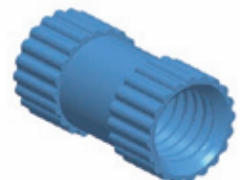

产品编号(NUMBER): M4×10
 产品名称(NAME): 铜套 COPPER NUT
 规格(STANDARD): M4×10
 材料(MATERIAL): 铜 COPPER
 用量(QUANTITY): 6 PCS
 颜色 (COLOR): 铜色 COPPER

⑤



产品编号(NUMBER): KM4×25
 产品名称(NAME): GRUB SCREW
 规格(STANDARD): M4×25
 材料(MATERIAL): STAINLESS STEEL
 用量 (QUANTITY): 6 PCS

⑥

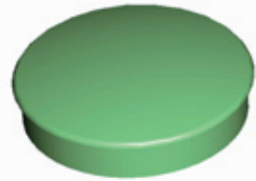

产品编号(NUMBER): KN-500-B1
 产品名称(NAME): 螺丝盖 SCREW LID
 模具编号(P/NO): BAH10001-A3
 材料(MATERIAL): ABS(LIGHT GREY:FS20412)
 用量(QUANTITY): 6 PCS

⑦

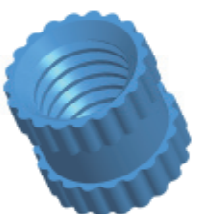

产品编号(NUMBER): M4×5
 产品名称(NAME): 铜套 COPPER NUT
 规格(STANDARD): M4×5
 材料(MATERIAL): 铜 COPPER
 用量(QUANTITY): 4 PCS
 颜色 (COLOR): 铜色 COPPER



名称 NAME	尺寸 SIZE (MM)	CARTON No.	G . W (KG)	N . W (KG)	每箱数量 QUANTITY	PE袋 POLYBAG
小箱 SAMLL CARTON						
大箱 BIG CARTON						