

产品型号(MODEL NO.): BMW 50006-A1

产品尺寸 (SIZE): 168×107×45MM

产品重量(WEIGHT): 167 g

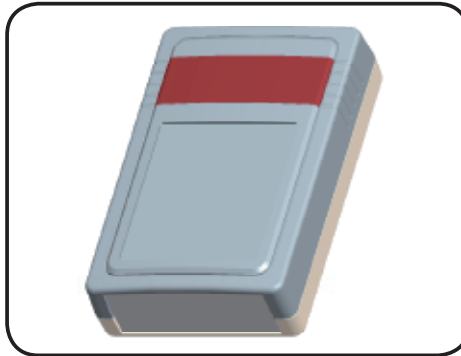

19221556

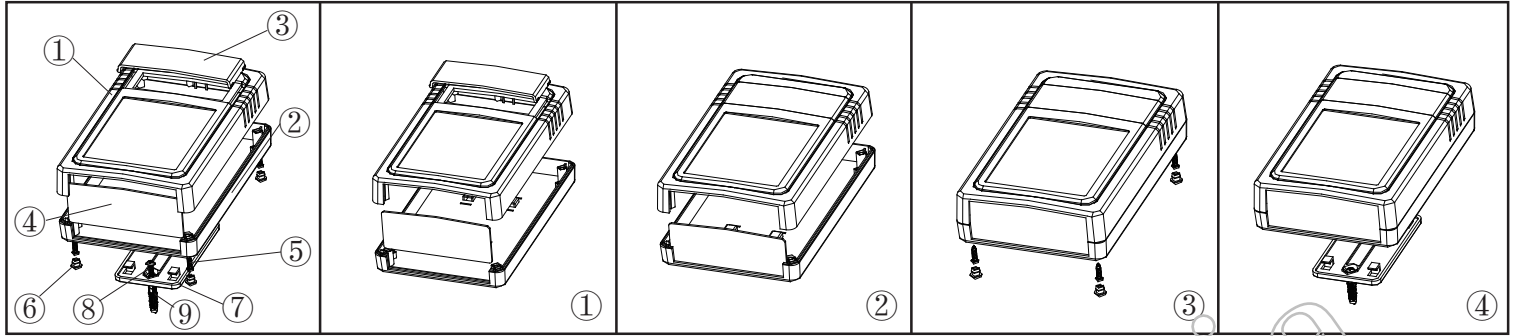

①



产品编号(NUMBER):50006-B1
 产品名称(NAME):上壳 EPIVALVE
 模具编号 (P/NO) :BAH10034-A1
 材料(MATERIAL):ABS(LIGHT GREY:FS20412)
 用量(QUANTITY):1 PCS
 重量(WEIGHT) : 76 g

②



产品编号(NUMBER):50006-C1
 产品名称(NAME):下壳 HYPOTHECA
 模具编号(P/NO): BAH10034-A2
 材料(MATERIAL):ABS(LIGHT GREY:FS20412)
 用量(QUANTITY): 1 PCS
 重量(WEITHG): 66 g

③

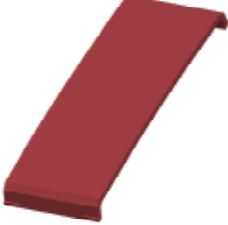

产品编号(NUMBER):50005-D1
 产品名称(NAME): TRANSLUCENT COVER
 模具编号 (P/NO) :BAH10033-A3
 材料(MATERIAL) :PC(茶色:0571)
 用量(QUANTITY): 1 PCS
 重 量(WEIGHT):-7 g

④



产品编号(NUMBER):50006-E1
 产品名称(NAME): 挡板 BAFFLE
 模具编号(P/NO): BAH10033-A4
 材料(MATERIAL):ABS(LIGHT GREY:FS20412)
 用量(QUANTITY): 1 PCS
 重量(WEITHG): 7 g

⑤



产品编号(NUMBER):PA3×14
 产品名称(NAME):圆头螺丝SELF-TAPPING SCREW
 规格(STANDARD): M3×14
 材料(MATERIAL):铁 IRON
 用量(QUANTITY): 4 PCS

⑥



产品编号(NUMBER): BP-8
 产品名称(NAME): 脚垫 FOOTPEAL
 模具编号(P/NO): BAH10020-A4
 材料(MATERIAL):PVC(WHITE:CM7070)
 用量(QUANTITY): 4 PCS
 重量(WEITHG) : 0.258 g

⑦



产品编号(NUMBER):50001-F1
 产品名称(NAME): 墙挂WALL TIE ACCESSORIES
 模具编号 (P/NO) :BAH10006-A5
 材料(MATERIAL):ABS(LIGHT GREY:FS20412)
 用量 (QUANTITY): 1 PCS
 重量(WEIGHT) : 12 g

⑧



产品编号(NUMBER):PWA3×25
 产品名称(NAME):圆头螺丝SELF-TAPPING SCREW
 规格(STANDARD): M3×25
 材料(MATERIAL):铁 IRON
 用量(QUANTITY): 2 PCS

⑨



产品编号(NUMBER): S-5
 产品名称(NAME): 墙钉 WALL NAIL
 模具编号 (P/NO) : BAH10032-A1A2
 规格(STANDARD): S×5 φ3-4
 材料(MATERIAL): PP(GREY :CM906)
 用量(QUANTITY): 2 PCS



名称 NAME	尺寸 SIZE (MM)	CARTON NO.	G. W (KG)	N. W (KG)	每箱数量 QUANTITY	PE袋 POLYBAG
小箱 SAMLL CARTON	188×116×54	47	0.219	0.174	1 (PCS)	281X174 (MM)
大箱 BIG CARTON	665×370×390	13	16.5	12.5	72 (PCS)	