

产品型号(MODEL NO.): BMW 50003-A1

产品尺寸 ( SIZE ): 200×145×64MM

产品重量(WEIGHT): 283 g

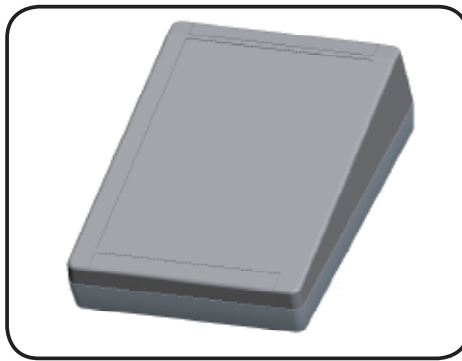

19221553

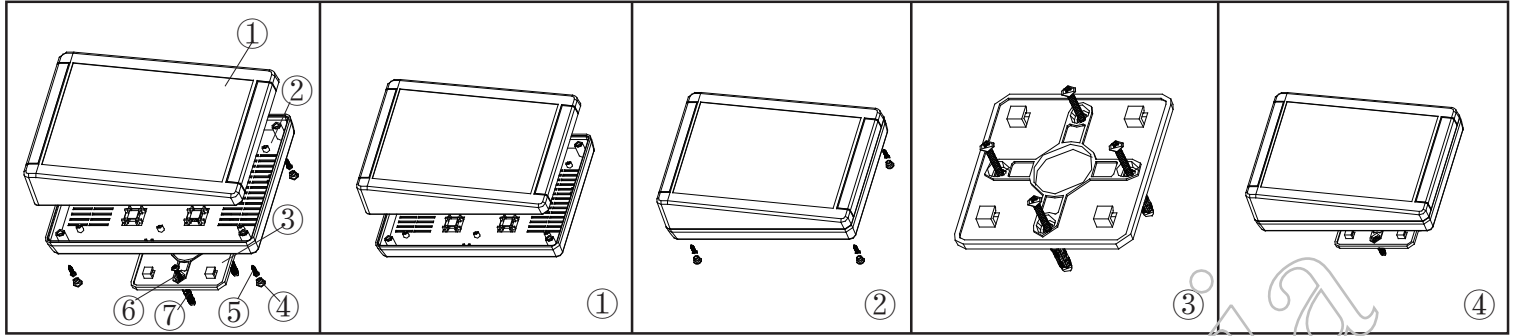

①



产品编号(NUMBER):50003-B1  
 产品名称(NAME):上壳 EPIVALVE  
 模具编号 (P/NO) :BAH10022-A1  
 材料(MATERIAL):ABS(LIGHT GREY:FS20412)  
 用量(QUANTITY):1 PCS  
 重量(WEIGHT) : 147 g

②

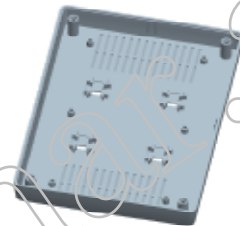

产品编号(NUMBER): 50002-C1  
 产品名称(NAME):下壳 HYPOTHECA  
 模具编号(P/NO): BAH1021-A2  
 材料(MATERIAL):ABS(LIGHT GREY:FS20412)  
 用量(QUANTITY): 1 PCS  
 重量(WEITHG): 110.5 g

③

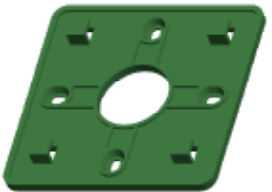

产品编号(NUMBER):50002-D1  
 产品名称(NAME):墙挂 WALL TIE ACCESSORIES  
 模具编号 (P/NO) :BAH110021-A3  
 材料(MATERIAL):ABS(LIGHT GREY:FS20412)  
 用量 (QUANTITY): 1 PCS  
 重量(WEIGHT) : 24 g

④



产品编号(NUMBER): BP-8  
 产品名称(NAME):脚垫 FOOTPEAL  
 模具编号(P/NO): BAH10020-A4  
 材料(MATERIAL):PVC(白色WHITE:CM7070)  
 用量(QUANTITY): 4 PCS  
 重量(WEITHG): 0.258 g

⑤



产品编号(NUMBER):PA3×12  
 产品名称(NAME):圆头螺丝SELF-TAPPING SCREW  
 规格(STANDARD): M3×12  
 材料(MATERIAL):铁 IRON  
 用量(QUANTITY): 4 PCS

⑥



产品编号(NUMBER):PWA3×25  
 产品名称(NAME):圆头螺丝SELF-TAPPING SCREW  
 规格(STANDARD): M3×25  
 材料(MATERIAL):铁 IRON  
 用量(QUANTITY): 4 PCS

⑦



产品编号(NUMBER): S-5  
 产品名称(NAME):墙钉 WALL NAIL  
 模具编号(P/NO): BAH10032-A1A2  
 规格(STANDARD): S×5 φ3-4  
 材料(MATERIAL): PP(GREY:CM906)  
 用量(QUANTITY): 4 PCS



名称 NAME	尺寸 SIZE (MM)	CARTON NO.	G. W (KG)	N. W (KG)	每箱数量 QUANTITY	PE袋 POLYBAG
小箱 SAMLL CARTON	226×156×95	37	0.338	0.293	1 (PCS)	263X263 (MM)
大箱 BIG CARTON	740×490×710	16	30.5	24.5	72 (PCS)	