

产品型号(MODEL NO.): BDC 30001-A2

产品尺寸 ( SIZE ): 156×114×79 mm

产品重量(WEIGHT): 145 g

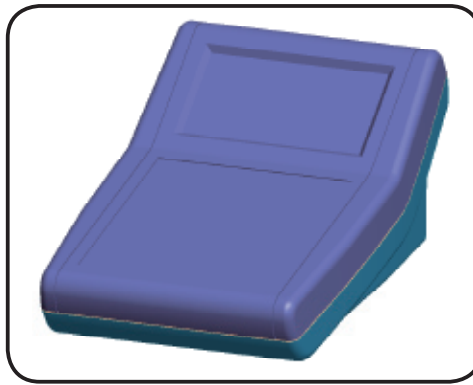

18221501

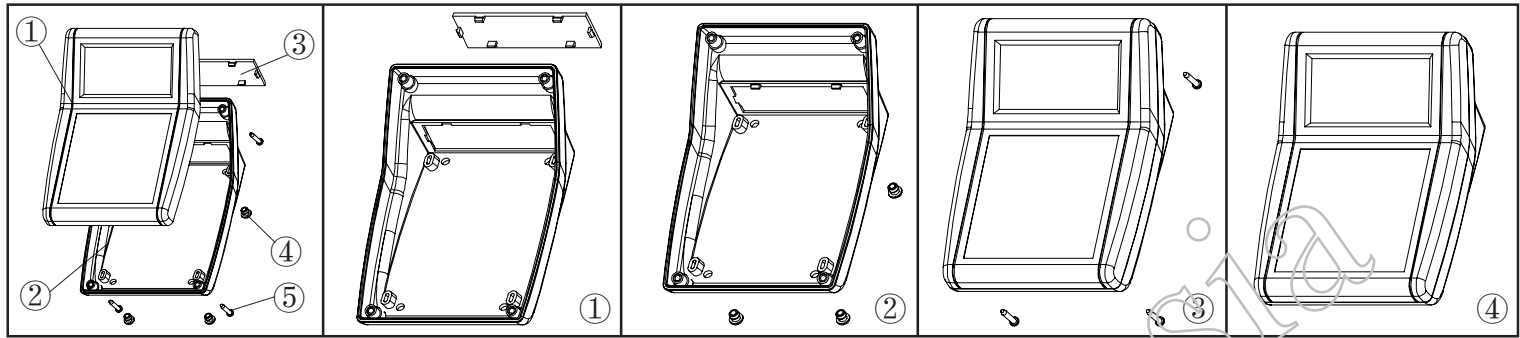

①

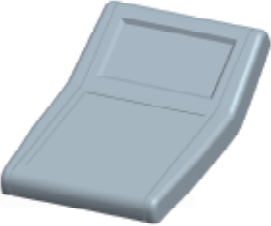

产品编号(NUMBER):30001-B2  
产品名称(NAME):上壳 EPIVALVE  
模具编号(P/NO):BAH10020-A1  
材料(MATERIAL):ABS(LIGHT GREY:FS20412)  
用量(QUANTITY):1 PCS  
重量(WEIGHT): 65 g

②

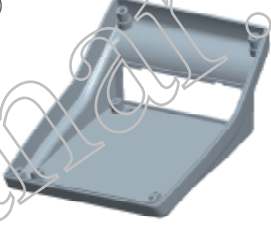

产品编号(NUMBER): 30001-C1  
产品名称(NAME):下壳 HYPOTHECA  
模具编号(P/NO): BAH10020-A2  
材料(MATERIAL):ABS(LIGHT GREY:FS20412)  
用量(QUANTITY): 1 PCS  
重量(WEIGHT): 72 g

③

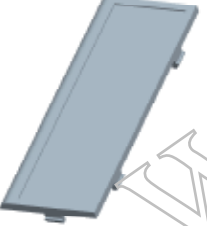

产品编号(NUMBER):30001-D1  
产品名称(NAME): 挡板 BAFFLE  
模具编号(P/NO): BAH10020-A3  
材料(MATERIAL):ABS(LIGHT GREY:FS20412)  
用量(QUANTITY): 1 PCS  
重量(WEIGHT): 6 g

④



产品编号(NUMBER): BP-8  
产品名称(NAME): 脚垫 FOOT PAD  
模具编号(P/NO): BAH10020-A4  
材料(MATERIAL):PVC(WHITE:CM7070)  
用量(QUANTITY): 4 PCS  
重量(WEIGHT): 0.258 g

⑤



产品编号(NUMBER):PA3×18  
产品名称(NAME):圆头螺丝SELF-TAPPING SCREW  
规格(STANDARD): M3×18  
材料(MATERIAL):铁 IRON  
用量(QUANTITY): 4 PCS



名称 NAME	尺寸 SIZE (MM)	CARTON No.	G . W (KG)	N . W (KG)	每箱数量 QUANTITY	PE袋 POLYBAG
小箱 SAMLL CARTON	186×131×112		0.223	0.148	1 (PCS)	305×169 (MM)
大箱 BIG CARTON	810×550×670		25	18	96 (PCS)	